

Separett[®] VILLA

Model 9220

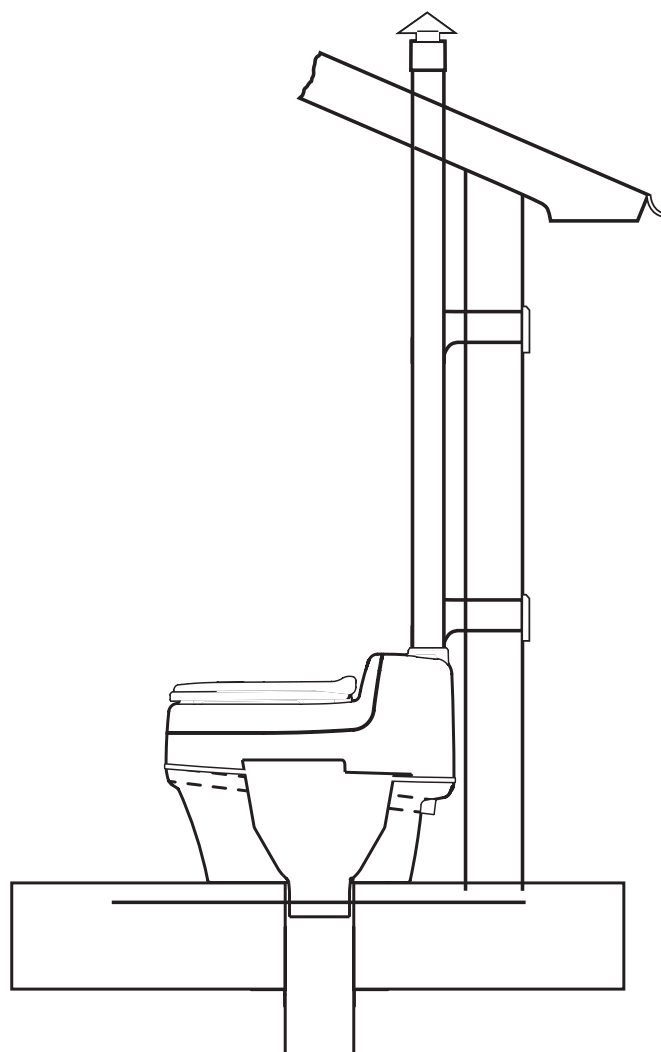

Separett[®]
Waterless Toilets

www.separett.com

TECHNICAL DATA

• Model 9220

Material

Upper/lower sections:

High impact,
high gloss polypropylene

Seat:

Gloss polypropylene

Inner bucket/cover:

Polypropylene

All materials can be recycled

Weight

28.7 pounds/13 kg

Dimensions

Ventilation pipe: Ca Ø 3 inches/75 mm

Urine drain: Ø 1.25 inches/32 mm

Electrical equipment

9220: Fan, 120V, 60 Hz, 14.6/18.9W

9220: Fan, 12V, 2.5W/210 mA

Electrical connection

9220: 4-foot/1.22 metre lead with
grounding plug; 4-foot/1.22 metre cable.

9220: Battery cable

Energy consumption

9220: 0.350/0.453 kWh/24 hrs.

9220: 0.06 kWh/24 hrs.

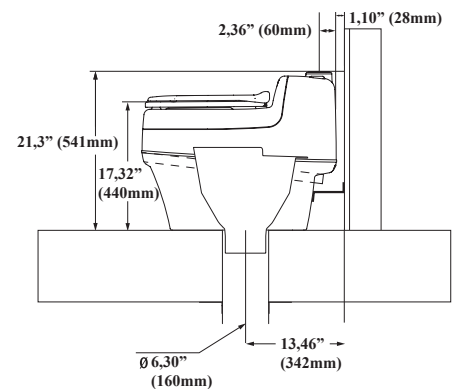
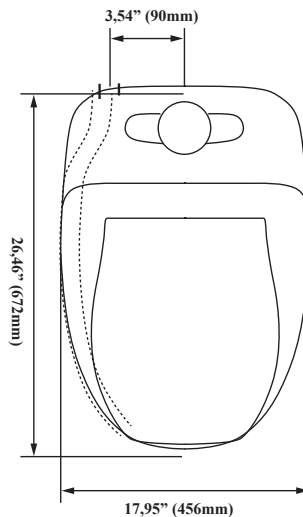

INSTALLATION

- Can be installed in both warm and cold areas.
- Only use plastic pipes.

Please refer to the installation film on www.separett.com

This is included with the product

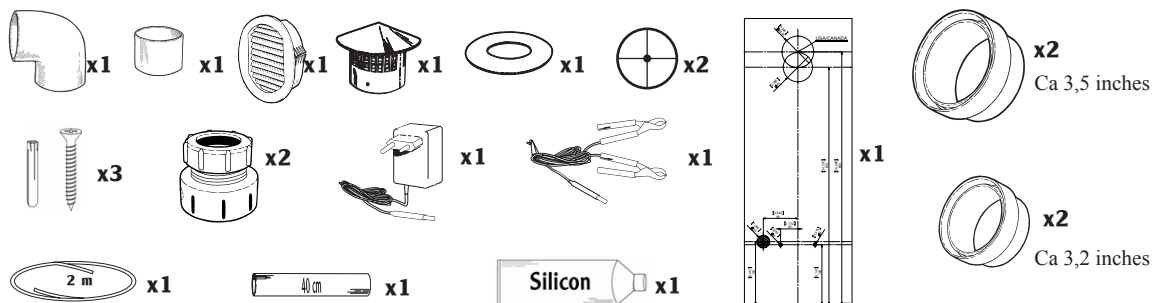

Useful tools

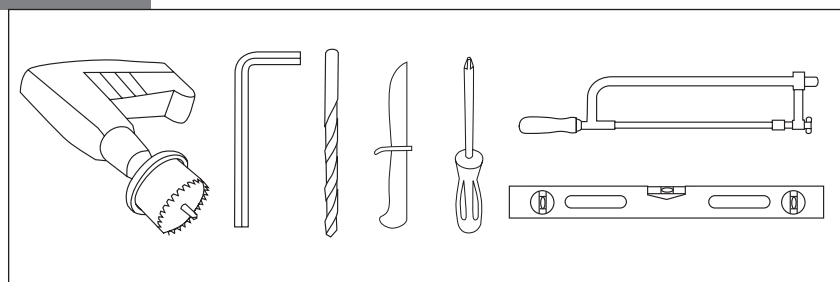

1 Installation advice

- First decide where you want to install the urine outlet and ventilation pipe together with the waste pipe.
- If the urine outlet or ventilation pipe pass through a wall, use the dimensioned drawing in Figure B: Ventilation pipe (1) Urine outlet (2).
- If the unit is permanently installed against a wall, please refer to the dimensioned drawing in Figure B (3).

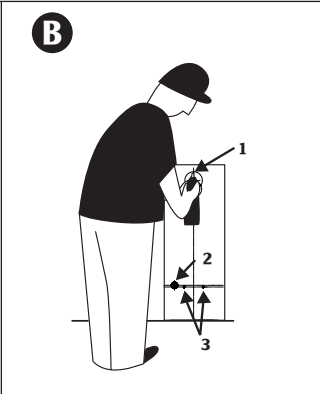
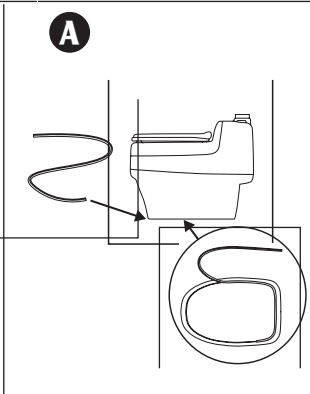
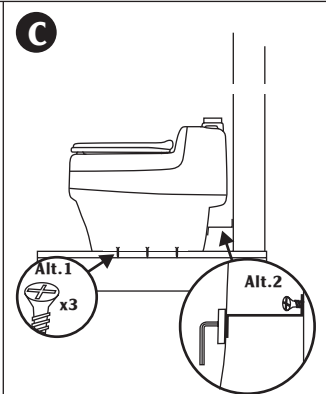
2 Urine outlet

- The urine outlet (alternatives A,B or C) must have a fall along its entire length.
- Use pipes when the drain passes through walls, floor, and for long distances. A larger diameter pipe is recommended for outdoor installation.
- Winter use: For winter use, increase the pipe diameter or increase the pipe diameter to Ø50-75 mm. It may be necessary to add a heating loop as well.
- Please ask the Environmental Protection, Public Health and Building departments about the rules applicable to your area.

3 Ventilation

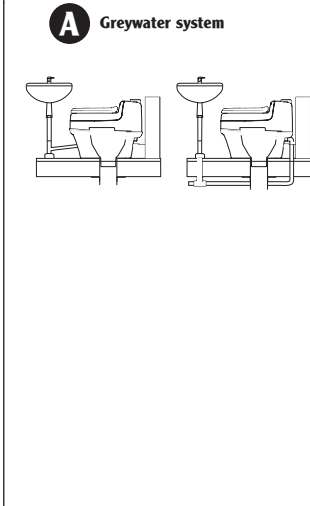
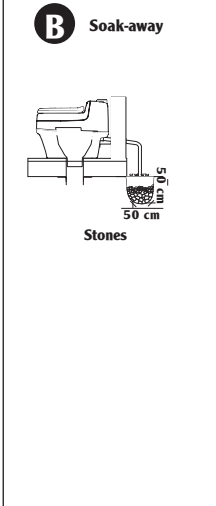
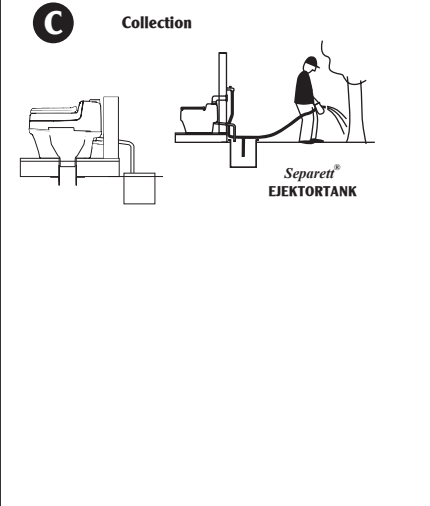
- Several components for alternative A are included in the package.
- Pipes can be connected to pipes from a previous toilet, minimum diameter Ø55 mm.
- Alternatives A, B and C are recommended for use with a 12 V fan.
- Horizontal pipes must be installed with enough fall to ensure that any condensation runs back towards the toilet.
- Condensed water runs out through the urine outlet.

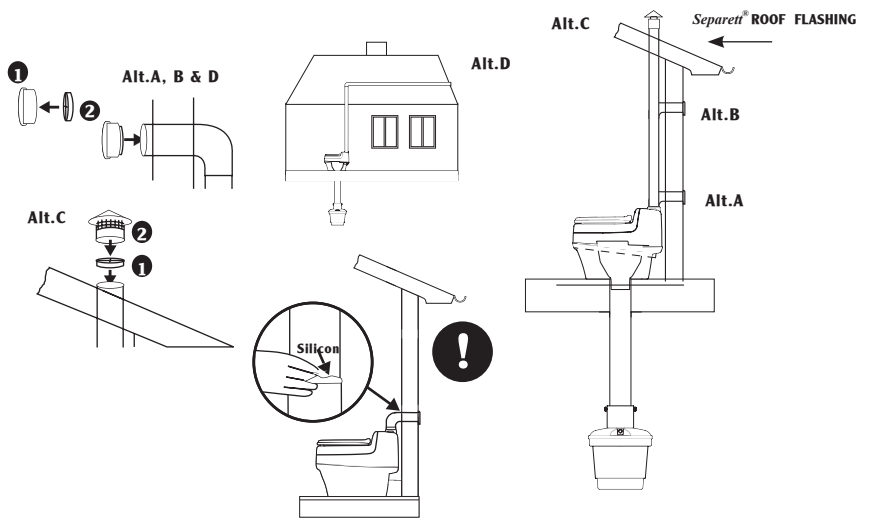

4 Drainpipes

- In the accessorie kit (not included) there are parts to connect the pipe about 1m between the toilet and the container.
- The pipe is pushed up against the funnel sitting in the toilet and is sealed with silicone. (1)
- The pipe is screwed underneath the floor bottom with bracket and screws. (2)
- The lower pipe is applied between the pipe and the lid of the container. This pipe can be pushed up on the pipe and be locked with knobs on each side. (3)

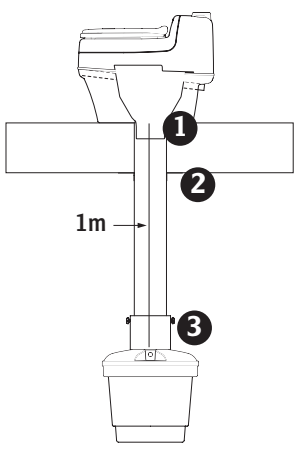

5 Check list

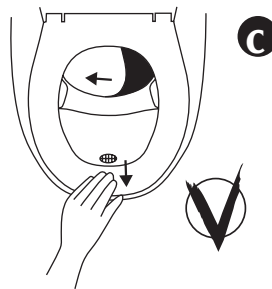
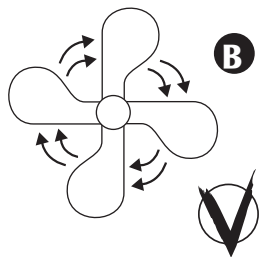
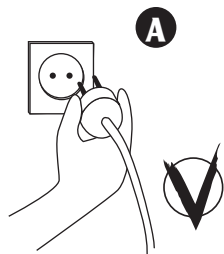

6 Before use

Separett® BIO DRAIN CLEANER

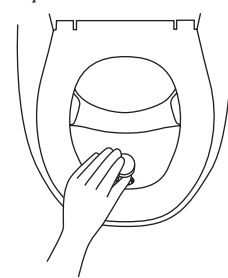

USE • The fan should run continually.

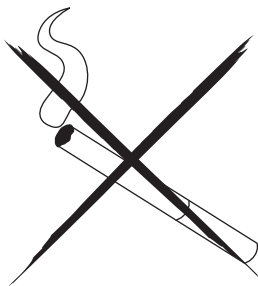

PROCESSING WASTE MATERIAL

• Please ask the Environmental Protection, Public Health and Building departments about the rules applicable to your area.

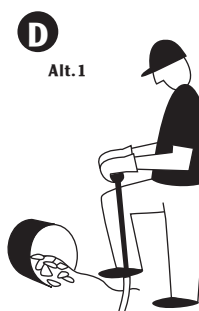
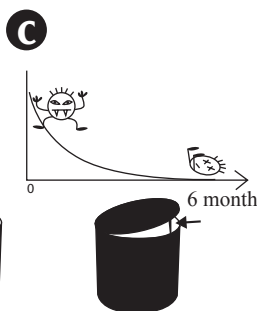
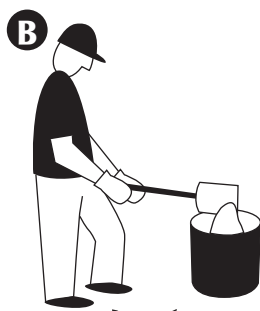

If the toilet does not work

The Separett Villa has been made and tested for best possible function and reliability. If it does not work as intended, however, please check the points below before contacting your dealer or Separett AB. **NOTE!** Disconnect the electric supply before doing anything else!

If flies have got into the toilet

- 1) Check that an insect net is installed.
- 2) Change to a new solid waste container. Use insecticide in the toilet and the bucket. Shut the fan off while the insecticide is working. Repeat the treatment after a few days.
- 3) If the fan is shut off, the container must be lifted out. Flies will otherwise be attracted to the contents.

If there is a smell in the bathroom

- 1) Is the fan running?
- 2) Has the filter on the fan housing been cleaned?
- 3) Have the joints on the ventilation pipe and urine outlet been sealed with silicone sealer?
- 4) If there is a floor outlet, check that you have a correctly-functioning water trap.
- 5) Check that the insect net on the ventilation pipe mouth has been cleaned.

If the container fills up too fast

- 1) Be economical with paper.
- 2) If urine constantly ends up in the container, it will take up too much space.

If urine ends up in the container

- 1) Slide the seat forwards by undoing the yellow nuts underneath, which will allow the user to sit in a position that encourages the urine to end up in the correct place.

If a smell occurs outdoors

- 1) Latrine smell. If urine ends up in the solid waste container there will be a latrine smell. Rectify this as above. We also recommend the use of Separett Absorb, which helps to keep the contents dry and smell-free.
- 2) Wastewater odour. If the urine outlet is connected to the soak-away, a bad smell might come from it. Install a water trap ("U" pipe) on the urine outlet.

If unwanted noise/vibration comes from the fan

- 1) Is the toilet correctly installed?
- 2) Clean the filter on the fan housing and the insect netting on the ventilation pipe mouth.

If the urine outlet is blocked

- 1) Use a drain unblocking preparation or a drain cleaning rod.

NOTE! Reduce the risk of deposits/blockage in the urine outlet by flushing with a small mug of water each time the toilet is used. We also recommend the use of Separett Bio drain cleaner, a biological block that is put in the urine bowl. The block decomposes and the enzymes counteract the problem of urine deposits in the waste pipe.

Warranty

.....
Product

.....
Model

.....
Serial no

.....
Date purchased

Dear Customer!

Thank you for choosing a product from Separett AB. This product has a 5 year warranty for manufacturing and/or material faults (not labour). However, the warranty does not cover normal wear and tear, incorrect use or care, and if the customer has caused any damage or modification to the product. If you have any questions about spare parts or the warranty, please contact the place where the product was purchased, or Separett's distributors. Please refer to the list at www.separett.com.

Do not forget to save your receipt!

IMPORTANT SAFEGUARDS

When using electrical products, especially when children are present, basic safety precautions should always be followed, including the following:

- READ ALL INSTRUCTIONS BEFORE USING -

Warning - To reduce the risk of burns, electrocution, fire or injury to persons:

- 1) Never touch cigarettes, cigarette butts or other burning or hot objects in the toilet.
- 2) Never put fingers inside fan openings.
- 3) Close supervision is necessary when this product is being used by or near children or invalids.
- 4) Use this product only for its intended use as described in this manual.
Use only attachments recommended by the manufacturer.
- 5) Never block the air openings of the product or place it on a soft surface, such as bed or couch, where the air openings may be blocked. Keep the air openings free of lint, hair and the like.
- 6) Never drop or insert any objects into ventilation openings.
- 7) Unplug this product before cleaning.
- 8) Never operate this product if it has a damaged cord or plug, if it is not working properly, if it has been dropped or damaged, or if it has been dropped into water.
Return the product to a service center for examination and repair.
- 9) Keep the cord away from heated surfaces.
- 10) Connect this product to a properly grounded outlet only.
- 11) Unplug this product before filling. Fill with water only, unless otherwise specified by the manufacturer. Do not overfill.

- SAVE THESE INSTRUCTIONS -

Separett[®]

www.separett.com